

Operating and Installation Instructions

This Product is Protected by U.S. Patent 8388322

CAUTION!

This product is to be installed only by persons knowledgeable in the repair and modification of vehicle fuel systems and general vehicle systems modification. Only a qualified technician or mechanic who is aware of applicable safety procedures and fabrication skills should perform the installation of this product.

This fuel pump utilizes an electronic DC motor system that is not typical of conventional fuel pumps, and therefore extra precautions must be adhered to as contained in instructions herein.

GASOLINE AND OTHER FUELS ARE FLAMMABLE AND CAN BE EXPLOSIVE!

Perform the installation in a well-ventilated location only to minimize the build up of fuel vapors. **NO** open flames, smoking or other sources of ignition are to be present during installation, to prevent fire or explosion that can cause serious injury or death. Grinding, cutting, and drilling must be performed with care to prevent ignition. Draining and removal of all fuel and ventilation of vapors in vehicle and fuel system is recommended when performing such procedures. Proper eye and personal protection are required at all times during installation.

WARNING!

The Vehicle's fuel system may be under pressure! Do not loosen any fuel connections until relieving all fuel system pressure. Consult an applicable service manual for instructions to relieve fuel system pressure safely.

This product is intended for racing, off-road, or marine use only. This fuel system component may not be legal for sale or use on emission-controlled motor vehicles; consult local, state, and national laws.

Product Contents:

Check the diagram and list of components (right) to ensure that no components are missing from box. Contact your Fuelab distributor immediately for replacement.

41401-c Features and Performance Ratings:

Inlet / Outlet Port Sizes	-10AN Military Port
Rated Flow Rate	125 GPH @ 45 PSI, 13.5V (473 LPH @ 3 Bar)
Maximum Pressure	125 PSI (8.5 Bar)
Operating Voltage	8-32 Volts
Maximum Current Draw	30 Amperes

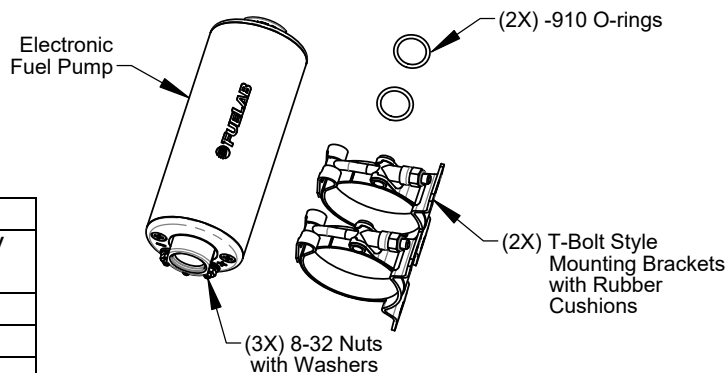

WARNING! Power Supply Voltage must be constant as specified in above specification. Only install fuel pump on vehicles using between 12 Volt (6 cell lead acid battery) and 24 Volt (12 cell lead acid battery) systems with or without a normal operating charging system. Pulse-Width Modulation or other means of reducing input power voltage may result in erratic or non-operational condition. Consult these instructions on using pulse width modulated signals for means of fuel pump speed control.

Before Installation, Plan Entire Fuel System:

A complete design plan of entire fuel system must be created for the specific application. These instructions are a guide to help design this plan with respects to integrating this model of fuel pump only. Consult other sources of information and manufacturer's instructions for the various components of the fuel system. These instructions are limited to general topics of fuel pump installation and may not include specific information pertaining to your specific application. These instructions are written assuming the use of Multi-Point Electronic Fuel Injection using a standard return (bypass) style fuel pressure regulator. This fuel pump may be integrated in some general carbureted systems using a bypass system only. Visit our company website (www.fuelab.com) for specific details pertaining to example fuel systems and other solution ideas. Additional information including advanced troubleshooting, any special alerts and FAQ's pertaining to this and other products is also available. A good design plan for the fuel system must contain consideration for: pressure and flow rate through various components, quality of components, operating environment (temperature, vibration, shock, general exposure to elements), local area laws, and racing or track rules. Begin installation of fuel pump only after a complete plan is established to help avoid fuel system component failure, costly rework, and excessive installation time.

Plumbing Planning Notes:

Fuel Pump is recommended for external use only. Inlet Straining Filter may be omitted if fuel system is cleaned, and only pre-strained fuel is used to fill the fuel tank or fuel cell with great care ensuring debris not to enter tank. Adequate structural mounting and support is the responsibility of the fabricator and installer. Mount the fuel pump as low as possible without it being vulnerable to road hazards or debris. Minimize the length of the fuel line feeding fuel pump. Do not use "cross drilled" style 90° elbow fittings, check valves or other restrictions (other than high flow fuel filter strainer or shut-off valve) before or upstream of fuel pump. Minimize plumbing restrictions between fuel tank and fuel pump and regulator for peak performance, use -10AN (5/8") or -12AN (3/4"). Typically -6AN (3/8") to -10AN (5/8") line is required for the rest of the fuel system, after or upstream of fuel pump. Use of a strainer filter upstream of fuel pump to reduce risk from foreign object damage. Special Note: Use only Fuelab 828xx or 868xx Series Filter with 100-Micron Rated Filter Element for -10AN or -12AN Line is recommended. All fuel line used must handle high pressure. The use of fuel line such as stainless-steel braided line and "AN" style fitting connections are recommended. The fuel ports (two -10AN Ports) use "AN" or "military" style fittings. This plumbing standard is commonly used with racing and high-performance applications. See Step 4 on Sheet 4, for additional information on this port standard. A fuel filter with a 60 micron or lower particle rating is required to be used upstream of regulator and downstream from fuel pump to protect it and the fuel injectors from foreign object damage. Reference the Schematic Diagram below for filter locations. Fuel tank must have a modification of an additional sump or use aftermarket fuel cell as indicated. Use of a "pick-up" tube system is not recommended. Use of a liquid filled gauge exposed to engine compartment heat is not recommended as the liquid inside the gauge may exert measurement errors, all mechanical gauges and pressure transducers have amounts of error due to temperature fluctuation, be aware of inaccurate pressure readings. **DO NOT** plumb gauge port to any gauge mounted inside the vehicle or in passenger compartment. A line burst can spill fuel inside passenger compartment and on occupants, possibly causing serious injury or death. An electronic gauge or pressure transducer system is recommended for readings in a passenger compartment.

Typical EFI V-8 Fuel System Plumbing Schematic Diagram:

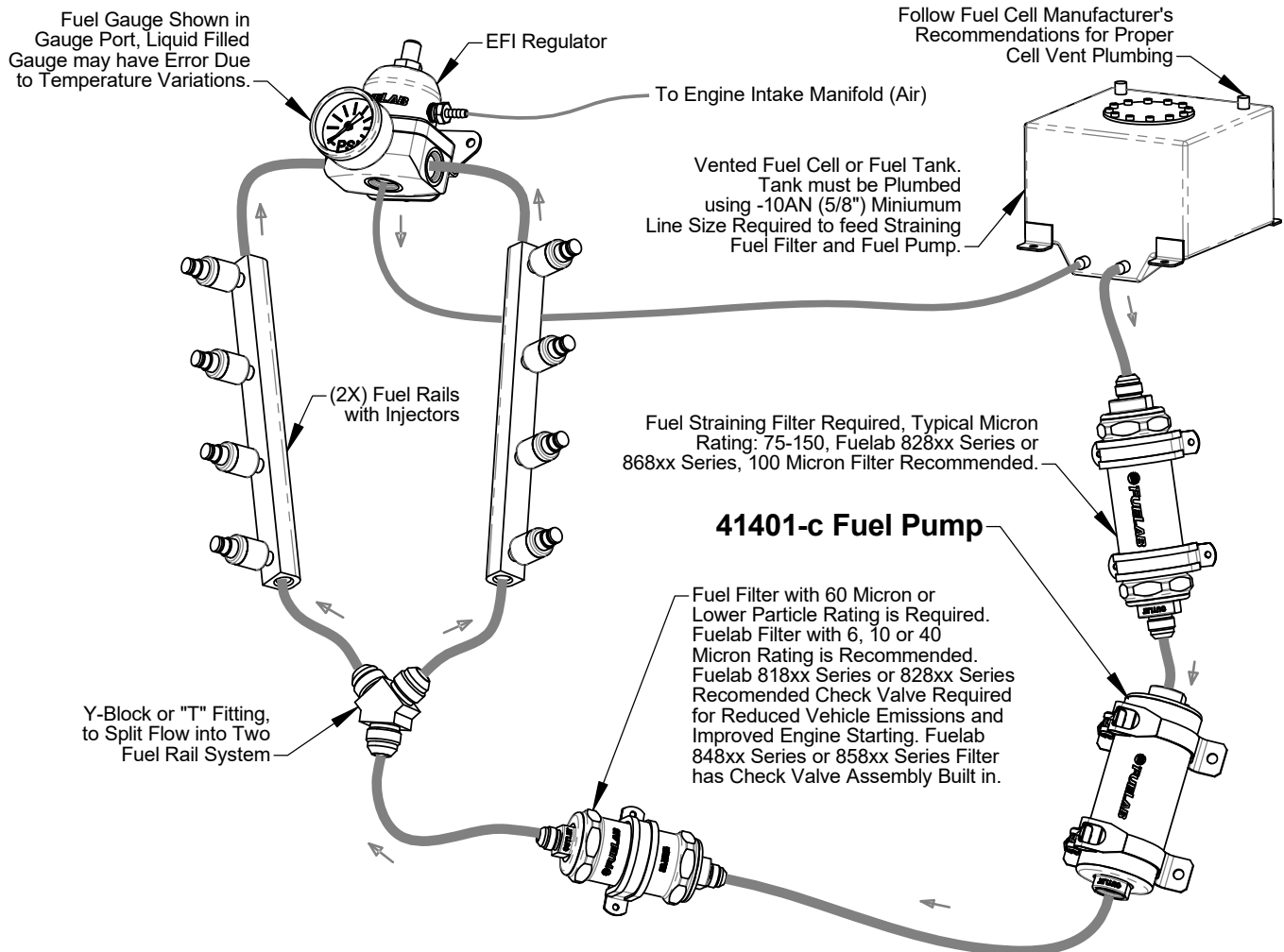

Special Note: Use in carbureted systems require a bypass return or relief valve.
Do not "Dead Head" Fuel Pump.

Electrical Planning Notes:

Reference Sheet 3 and 4 for schematic wiring diagram examples. Use electrical components as described including electrical connectors that are appropriate for the operating environment of the fuel system, whether its use in street, racing, or marine applications. Electrical connectors for the power leads must be capable of high current draw, note all connections, wire, and component rating requirements herein. Solder and use shrink wrap for wire splices for extra reliability (unless high quality crimping is performed). Use of a check valve in fuel system as shown in plumbing diagram will maintain fuel pressure at normal levels during engine starting and may be required depending on the wiring of main relay control circuit. (OEM and some aftermarket ECMs have fuel pump relay control outputs that will turn off fuel pump during engine starting, requiring check valve use.) If the fuel pressure does not maintain during engine starting, ensure fuel pump is energized while starting. Main wiring schematic diagram below shows the control of relay by ignition switch. This source can be changed as described, or by a toggle switch. Some forms of racing have specific rules regarding electrical switching of fuel pump. Consult appropriate racing guidelines, rules, and regulations.

MAIN WIRING SCHEMATIC DIAGRAM: (Some electrical components shown are not supplied with kit)

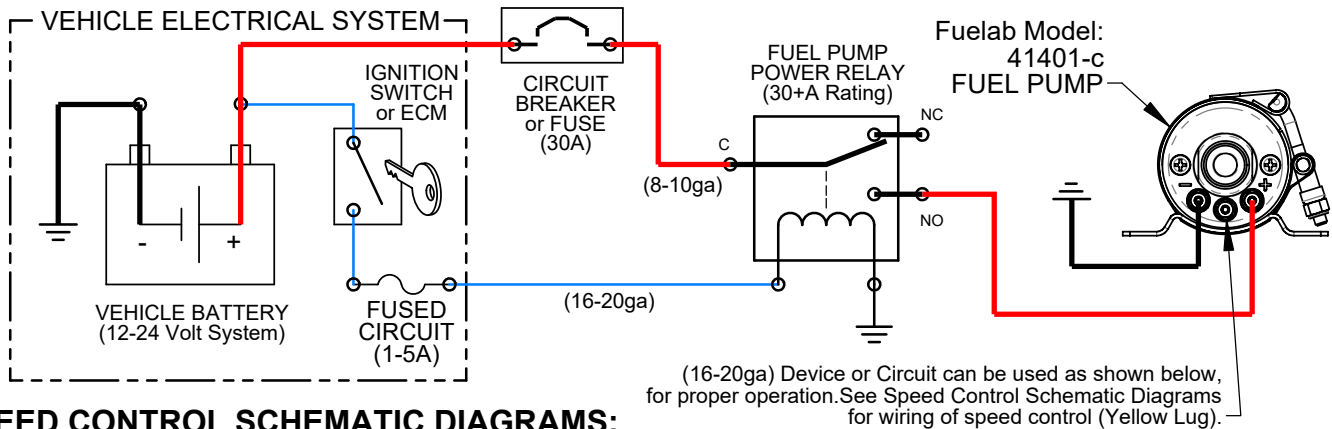

SPEED CONTROL SCHEMATIC DIAGRAMS:

The speed control terminal (Yellow Center Lug) can have voltage or a signal applied to it. When the speed control terminal has less than 0.25V (Approx) applied to it, the mode of operation is in continuous reduced speed. When the speed control terminal has greater than 1.65V (Approx), the mode of operation is in continuous maximum speed. A pulsed signal may also be used to control pump speed. See examples below for a method suitable for your application.

Example 1: Continuous Maximum Speed

Attach no wiring to speed control terminal, to operate pump at continuous maximum speed. The performance curve was recorded as shown on the Pump Certification as "Maximum Speed". Use Example 1 for racing specific applications, or short interval use. Use in continuous maximum speed may cause overheating and therefore may damage fuel pump. Additional cooling may be required using maximum speed only while operating with low engine demand for extended periods.

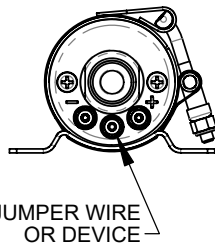

Example 2: Continuous Reduced Speed

Attach a jumper wire as shown below, to operate pump at continuous reduced speed. The reduced speed is preset, with the performance curve shown on the pump certification. See schematic, attach wire between negative terminal (Black Lug) and Yellow Lug. Use Example 2 if the flow rate at reduced speed is adequate for application. Using this mode of operation is considered continuous duty. See Examples 3 and 4 for switching between maximum and reduced speed.

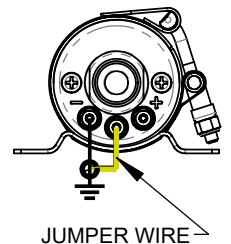

Example 3: Switch to Ground Speed Changing

Attach switch and wiring as shown to the right, to operate pump at continuous maximum speed while switch is in the open position (position as shown in diagram). When the switch is in the closed position (on), the pump will operate in reduced speed mode. To reverse the desired switch action, refer to Example 4. Switch type can be a relay or switching based on pressure or other means. Current draw through this circuit is extremely low (much less than 1 amp), so a very low current rating for this switch can be used. Use the diagram to the right as a guide to properly wire this example. Reduced speed is recommended during long periods of low engine fuel demand conditions to avoid fuel system heat build-up.

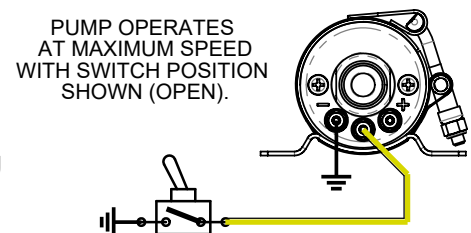

SPEED CONTROL SCHEMATIC DIAGRAMS: (cont.)

Example 4: Switch to Power Speed Changing

When the switching action is in reverse to what can be used as shown Example 3, such as some pressure switches, the action can be reversed using a Single Pole Dual Throw (SPDT) relay as shown to the right. Current draw through this circuit is extremely low (much less than 1 amp), so a very low current rating for this relay and switch can be used. Use the diagram to the right as a guide to properly wire this example. Reduced speed is recommended during long periods of low engine fuel demand conditions to avoid fuel system heat build-up.

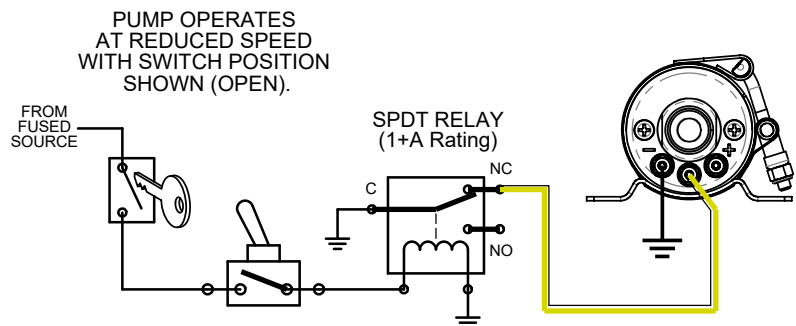

Example 5: Variable Speed

Devices such as an aftermarket ECM can create a pulsed signal ("pulling" voltage to ground at a given frequency). This signal has a characteristic of dwell time, which is a ratio of on-time vs. off-time (in other words, the amount of time the signal is "high" vs. "low"). This difference in dwell time percentage will enable the fuel pump to operate at various speeds or flow rate. A graph demonstrating an example signal created by such a device is shown below. The example signal is at 66% duty cycle, whereas the amount time that the signal is above 1.65V voltage is about twice the amount of time at zero volts. When duty cycle is between 5%-20%, the fuel pump is turned off. A duty cycle between 20%-90% will be variable speed between Minimum and Maximum Speeds, while duty cycles of 90%-100% are at Full Speed. Frequency range is allowed between 100Hz and 5000Hz. "High" voltage may be as high as the vehicle's voltage.

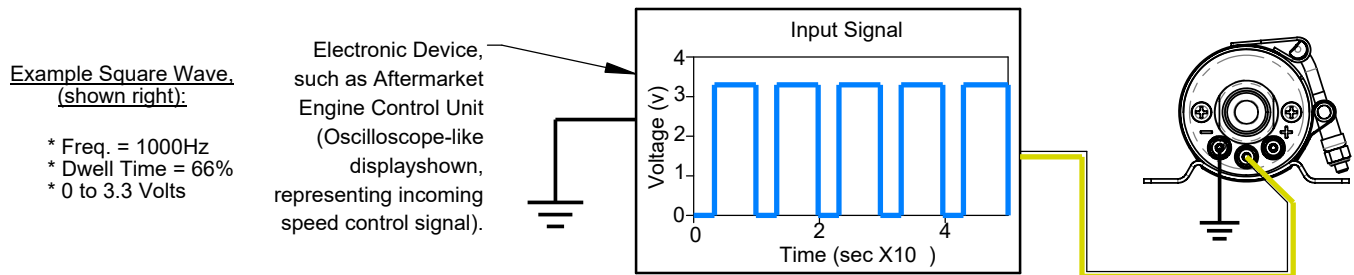

Refer to above Example 5, for use with the Fuelab Electronic Fuel Pressure Regulator, Models 52901 and 52902, that creates its own pulsed signal. These regulators automatically control the fuel pump, without the use of switching means or other components such as described in examples 2 and 3. Refer to instructions for the Electronic Regulator for proper wiring and installation.

Installation Steps:

1. Disconnect the ground terminal from battery and allow the vehicle's engine and exhaust system to cool. Relieve fuel system pressure per applicable service manual. Follow all Warnings, Cautions and Instructions written on previous pages of these instructions.
2. Modify, remove or replace other fuel system components as required per established build plan (reference notes on previous pages and above).
3. Use the supplied brackets attached to the fuel pump, as a drilling template to mark holes for mounting bracket. Choose a location that minimizes exposure to road hazards and debris, away from engine exhaust pipes, near fuel tank or cell. Note position and plumbing requirements as stated earlier in these instructions.
4. Install the fuel fittings (not supplied). The threads used on these fuel ports are not tapered or pipe threads. Do not use Teflon® thread tape or thread sealant on these threads, as this can cause leakage or introduce debris into the fuel system. Fittings to be used with these style of ports require use of the enclosed -910 o-rings for proper sealing. Use light oil to lubricate the o-rings just prior to installation. Install the O-rings onto the fuel fitting first. Position the o-ring in the thread relief of the fitting. Thread fitting into fuel pump and tighten between 5 and 15 ft·lbs of torque. **ALL** fuel line that is internal to tank **MUST** be fuel compatible both inside and outside of the line. PTFE based fuel line is recommended for a long service life.
5. Upon installation of fuel tank or cell and installation of all other fuel system components, Inspect fuel system for any contact of fuel lines or wires with other components that can cause chafing or rubbing. Secure all components and fuel lines. Ensure that moving components of vehicle are clear.
6. Connect the vehicle's battery. Perform initial priming: The fuel pump may require priming during initial operation and for moment after depletion of fuel from fuel tank or cell. This action can be accomplished by removing fuel line from fuel rail (downstream of fuel pump and filters), allowing the fuel line to empty fluid into

fuel safe container. Operate fuel pump until fuel exits fuel line. Attach fuel line back to the fuel rail after priming fuel pump. After tightening connection, verify leak-free operation while checking fuel rail pressure. If fuel pressure is not high enough, repeat priming procedure to ensure that fuel pump is receiving fuel from tank. Turn on fuel pump (typically by bypassing fuel pump relay) without engine operating. ECU or engine management computer may be controlling the relay. The ECU may only operate pump for a few seconds each time ignition switch is set to on. The pump will have to operate several seconds (30+) to prime and drive air out of the fuel system. Reattach fuel rail line. Start fuel system and inspect for leaks. Inspect vehicle for any leaks. Turn off fuel system and repair any leaks that may be present before continuing.

7. When adjusting pressure, be sure that fuel pump is operating to monitor pressure. Fuelab recommends to use a "baseline" pressure reference when adjusting the pressure (adjusting the pressure with engine off or pressure reference line or vacuum line unhooked). The vehicle's engine may not produce consistent vacuum during idle to have repeatable readings.
8. After final adjustment of fuel pressure, tighten jam nut. Road test vehicle, and retest pressure upon return to ensure accurate adjustment. After installation of this fuel pump, verify flow capacity to ensure safe levels of flow, particularly with reduced levels of pump speed. Having insufficient flow capacity can result in an engine lean-out condition that can cause severe engine damage. Collecting a given amount of fuel (as measured by weight or volume) over a measured amount of time can be used to determine capacity. Collect fuel flow from the return line to measure the amount of fuel capacity at a given operating pressure. A 20+ ampere capacity battery charger may be used to simulate the charging system of the vehicle while engine is off. If using an adjustable fuel pressure regulator, for boosted applications, simulate boost by raising the fuel pressure by the amount of expected maximum boost pressure. Performing these tests will give greater accuracy for capacity tests.

Fuel System Maintenance Notes:

Periodic inspections and general maintenance are required for longevity and reliability of the fuel system. This action directly affects the fuel pump's performance and reliability. Included with that are periodic inspection and/or filter element replacement. The straining filter (upstream of pump) should be checked and cleaned at least every 30,000 miles (more often for off-road operating conditions). Replace or clean downstream filters (after pump) every year or 15,000 miles (more often for off-road operating conditions). Dirty fuel filters can block flow and adversely effect fuel system performance as well as can directly damage the fuel pump. *Special alert for E85 or Methanol Users: **DO NOT** use cellulose (paper) based filter elements!* Water can contaminate the fuel and break down the element, creating debris that can damage injectors and fuel pump. E85 and other oxygenated fuels can absorb water. Long term storage of this fuel within the fuel tank of vehicle is not recommended and can contribute to rusting of the fuel pump's tool steel components. Draining the fuel tank and replacement with small amount of Gasoline or Kerosene (along with operating the fuel system for a small period of time) is recommended for long term storage of the vehicle.

Troubleshooting Notes:

Problem (Symptom)	Possible Causes	Possible Solutions
Not operating or slight "clicking" sound when turned on.	<ul style="list-style-type: none"> • Faulty fuel pump relay. • Faulty, dirty, or corroded terminals or improperly sized wire. • Debris from tank or plumbing lodged inside pump. 	Check voltage to controller, at power terminals. If voltage is steady and consistent (within 1/2 Volt of battery) then contact Fuelab for assistance or repair. If voltage is inconsistent as described, repair or replace electrical components as required.
Not building up fuel pressure.	<ul style="list-style-type: none"> • Incorrect fuel system initial priming procedure. • Pump operating in reverse direction (see above). 	Repeat procedure for proper priming. If condition continues, check all plumbing upstream (on inlet side) of fuel pump.
Leakage of fuel at inlet or outlet fuel ports.	<ul style="list-style-type: none"> • Improper type of fitting used. 	If leakage occurs at fitting, be sure that the proper fitting style is used (AN o-ring seal type ONLY!). Pipe threaded style fittings are NOT to be used.
Loss of fuel pressure or erratic pressure pulsation after several minutes of operation.	<ul style="list-style-type: none"> • Cavitation (vapor lock) due to overheating or restricted inlet. 	Look for sources of heat such as exhaust or fuel rail mountings that could be conducting too much heat. Check for inlet restrictions such as improperly vented tank, or debris blocking inlet straining filter. Contact Fuelab, as pump may be damaged due to improper operating condition for repair or consultation.

LIMITED LIFETIME WARRANTY

FUELAB, a division of FCP, Inc., having its principal place of business at **1605 Eastport Plaza Drive, Suite 125, Collinsville, IL 62234, USA** ("Manufacturer") warrants its **FUELAB** products (the "Products") as follows:

1. Limited Lifetime Warranty

Manufacturer warrants that the Products sold hereunder will be free from defects in material and workmanship from the date of purchase for so long as the original purchaser owns the Products. This Limited Lifetime Warranty does not extend to any subsequent owner or transferee of the Products. If the Products do not conform to this Limited Lifetime Warranty during the warranty period (as herein above specified), Buyer shall notify Manufacturer in writing of the claimed defects and demonstrate to Manufacturer's satisfaction that said defects are covered by this Limited Lifetime Warranty. If the defects are properly reported to Manufacturer within the warranty period, and the defects are of such type and nature as to be covered by this Limited Lifetime Warranty, Manufacturer shall, at its option and own expense, furnish replacement Products or replacement parts for the defective Products or refund the purchase price. Removal of Products from vehicle, shipping to Manufacturer and installation of the replacement Products or replacement parts shall be at purchaser's expense. (*Vehicle means any automotive, bike or marine transportation device powered by an internal combustion engine to which the Product is attached. This Product is **NOT** intended or designed for use on aircraft, experimental or otherwise.*)

2. Other Limits

THE FOREGOING IS IN LIEU OF ALL OTHER WARRANTIES, EXPRESS OR IMPLIED, INCLUDING BUT NOT LIMITED TO THE IMPLIED WARRANTIES OF MERCHANTABILITY AND FITNESS FOR A PARTICULAR PURPOSE. This Limited Lifetime Warranty does not cover any damage due to: (a) transportation; (b) storage; (c) improper use; (d) failure to follow instructions for the Products or to perform any preventive maintenance; (e) modification; (f) unauthorized repair; (g) normal wear and tear; or (h) external causes such as accidents, abuse, or other actions beyond Manufacturer's reasonable control. This Limited Lifetime Warranty also does not apply to Products upon which repairs have been effected or attempted by persons other than pursuant to written authorization by Manufacturer. This Limited Lifetime Warranty is not extended if we repair or replace the Products.

3. Exclusive Obligation

THIS LIMITED LIFETIME WARRANTY IS EXCLUSIVE. The sole and exclusive obligation of Manufacturer shall at its option be to repair or replace the defective Products in the manner and for the period provided above or to refund the purchase price. Manufacturer shall not have any other obligation with respect to the Products or any part thereof, whether based on contract, tort, strict liability or otherwise.

4. Other Statements

ORAL OR OTHER WRITTEN STATEMENTS BY MANUFACTURER'S EMPLOYEES, REPRESENTATIVES AND/OR RESELLERS DO NOT CONSTITUTE WARRANTIES, SHALL NOT BE RELIED UPON BY BUYER, AND ARE NOT A PART OF THE CONTRACT FOR SALE OR THIS LIMITED LIFETIME WARRANTY.

5. Entire Obligation

This Limited Lifetime Warranty states the entire obligation of Manufacturer with respect to the Products. If any part of this Limited Lifetime Warranty is determined to be void or illegal, the remainder shall remain in full force and effect.

6. Warranty Service

How Do You Get Service?

If something goes wrong with your Product, contact FUELAB at 618-344-3300, or send an e-mail with proof of purchase to: info@fuelab.com for a Return Authorization Number (RMA). After receiving your RMA send the product postage paid, fully insured, with a brief written description of the problem to:

FUELAB Warranty Department, 1605 Eastport Plaza Drive, Suite 125, Collinsville, IL 62234

We will inspect your Product and contact you within three business days of receipt to give the results of our inspection and an estimate of the labor and/or parts charges required to fix the Product, if applicable. If covered under this Limited Lifetime Warranty, Manufacturer will repair or replace the Product and return it to you at no cost or refund the purchase price. If the Product is NOT covered under this warranty and if you authorize repairs, we will return the repaired Product to you COD, or prepaid via credit card, within three business days. If we find no issues with the returned product and it meets all performance specifications, there will be a \$25 charge to cover technician labor and inspection time. Additional return shipping charges will apply. We will return the repaired Product to you COD, or prepaid via credit card, within three business days.

Limitation of Liability

THE REMEDIES DESCRIBED ABOVE ARE YOUR SOLE AND EXCLUSIVE REMEDIES AND OUR ENTIRE LIABILITY FOR ANY BREACH OF THIS LIMITED LIFETIME WARRANTY, OUR LIABILITY SHALL UNDER NO CIRCUMSTANCES EXCEED THE ACTUAL AMOUNT PAID BY YOU FOR THE DEFECTIVE PRODUCT, NOR SHALL WE UNDER ANY CIRCUMSTANCES BE LIABLE FOR ANY CONSEQUENTIAL, INCIDENTAL, SPECIAL OR PUNITIVE DAMAGES OR LOSSES, WHETHER DIRECT OR INDIRECT.

SOME STATES DO NOT ALLOW THE EXCLUSION OR LIMITATION OF INCIDENTAL OR CONSEQUENTIAL DAMAGES, SO THE ABOVE LIMITATION OR EXCLUSION MAY NOT APPLY TO YOU.