

Operating and Installation Instructions

CAUTION!

This product is to be installed only by persons knowledgeable in the repair and modification of vehicle fuel systems and general vehicle systems modification. Only a qualified technician or mechanic who is aware of applicable safety procedures and fabrication skills should perform the installation of this product.

GASOLINE AND OTHER FUELS ARE FLAMMABLE AND CAN BE EXPLOSIVE!

Perform the installation in a well ventilated location only to minimize the build up of fuel vapors. **NO** open flames, smoking or other sources of ignition are to be present during installation, to prevent fire or explosion that can cause serious injury or death. Grinding, cutting, and drilling must be performed with care to prevent ignition. Draining and removal of all fuel and ventilation of vapors in vehicle and fuel system is recommended when performing such procedures. Proper eye and personal protection is required at all times during installation.

WARNING!

The Vehicle's fuel system may be under pressure! Do not loosen any fuel connections until relieving all fuel system pressure. Consult an applicable service manual for instructions to relieve fuel system pressure safely. This product is intended for racing, off-road, or marine use only. This fuel system component may not be legal for sale or use on emission controlled motor vehicles; consult local, state and national laws.

Product Contents:

Check the diagram and list of components (below-right) to ensure that no components are missing from box. Contact your Fuelab distributor immediately for replacement.

23904 Features:

Compatible With	Models 60711, 60712, 61711, 61712 or 61713 FST Systems
Included Filter	Model 81832 with -8AN Inlet Fitting Size, 6u element

Before Installation, Plan Entire Fuel System:

This kit is specifically designed to be compatible with either Fuelab Models: 60711, 60712, 61711, 61712 or 61713 Fuel Surge Tank Systems (235mm tall versions). If this kit is intended to be used with other Models of a Fuelab Fuel Surge Tank System, please contact Fuelab distributor immediately for replacement or consultation. This kit includes fuel filter Model 81832-1, using -8AN Inlet Fitting Size (to mate with the supplied hose assembly, and 6u micro-fiberglass element with E85 and Gasoline Fuel Compatibility). Use of other filter assembly combination is

NOT recommended as the hose assembly may have undue force applied that can cause leakage or hose failure. Replacement of supplied hose assembly is **REQUIRED** if other than supplied filter and bracket is intended for use.

A complete design plan of entire fuel system must be created for the specific application. Refer to instructions outlined in relevant Product Instructions for proper installation of this kit (including Fuel Surge Tank – not supplied).

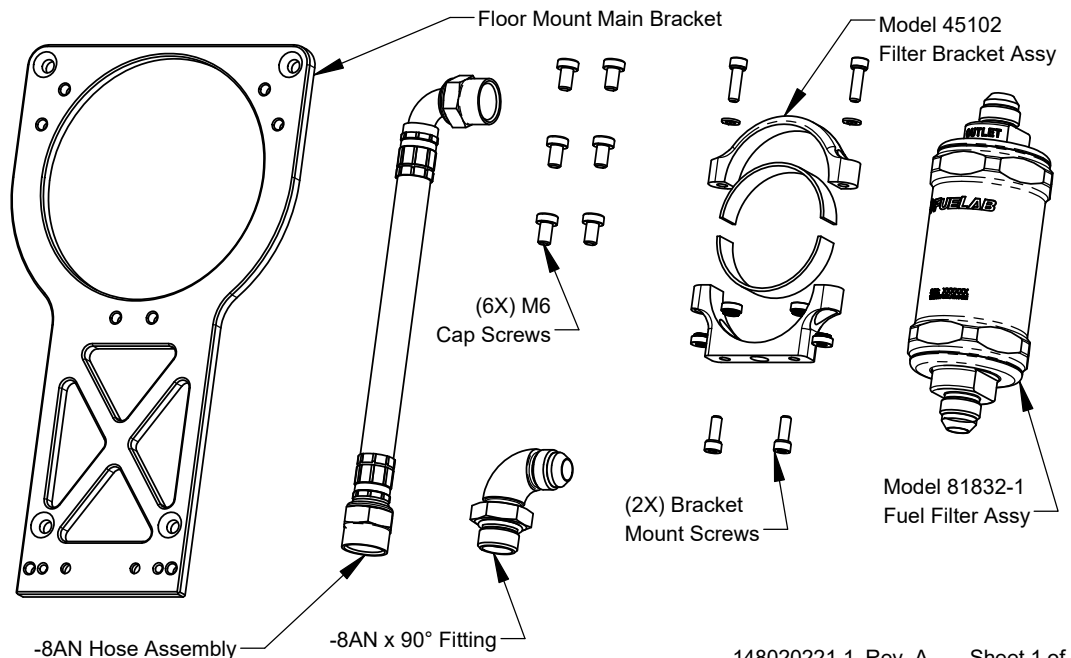

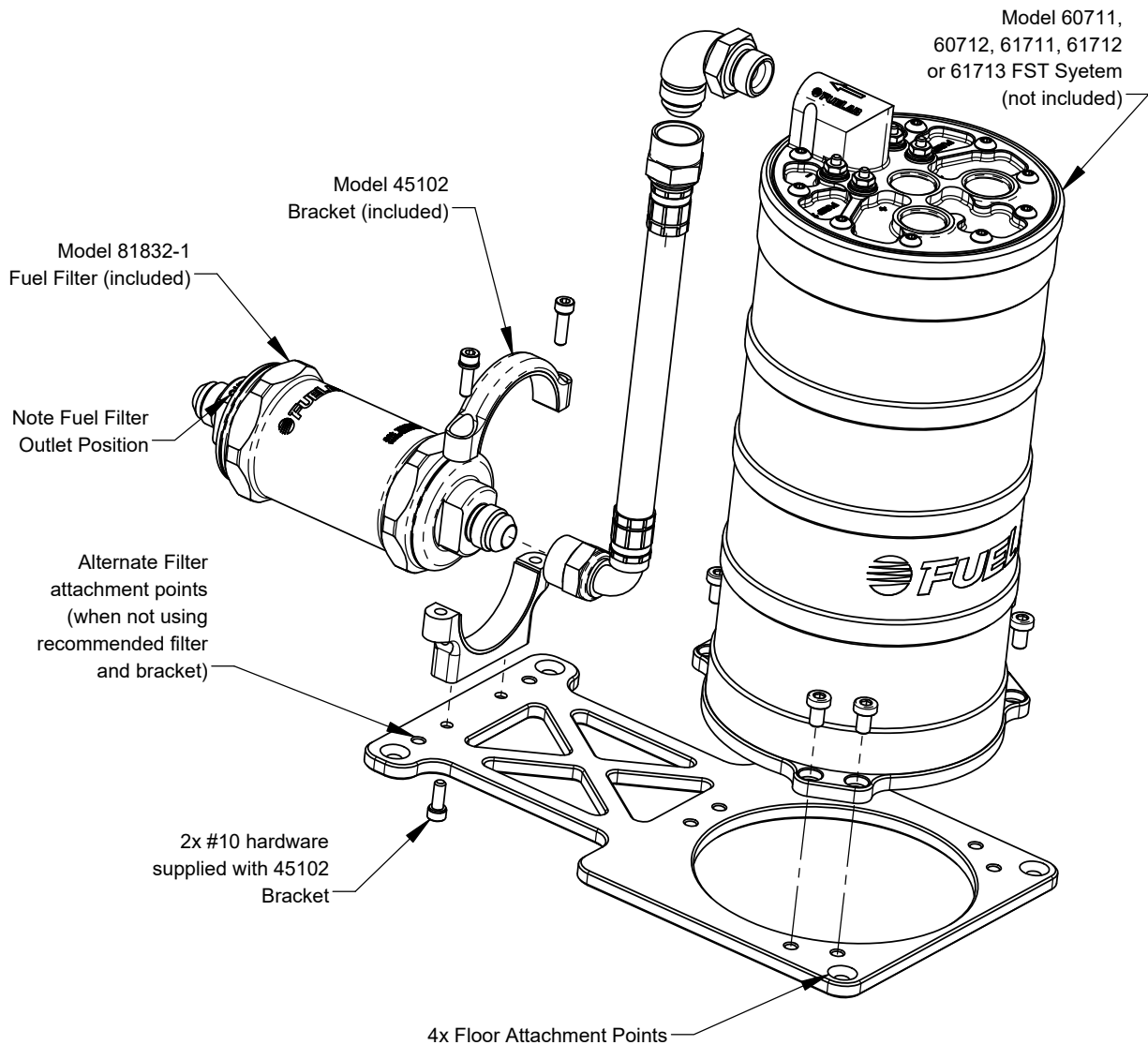

BRACKET SET ASSEMBLY:

Reference above for assembly diagram example. Tighten #10 Screws used with the Model 45102 Bracket Kit and supplied M6 Cap Screws to 40+/-5 in·lbs of torque. Use of thread adhesive for M6 Cap Screws is recommended. Torque -8AN Hose Fittings between 5 and 15 ft·lbs of torque, DO NOT Use thread adhesive nor Teflon Tape on fittings used with supplied Hose Assembly.

Install -8ANx90° Fitting by threading end as shown into FST System Outlet. When fitting is aligned downward (and nearly bottoming of the nut), tighten nut (to above torque specification). Install Hose Assembly, followed by filter assembly. From this point of assembly, M6 Cap Screws and Filter Bracket can be installed to complete assembly. **BE SURE TO FOLLOW ALL OTHER INSTALLATION INSTRUCTIONS TO COMPLETE ASSEMBLY.**

Please do not return this product to your retailer. If you experience any performance, reliability or problems during installation or use of this product, please contact Fuelab immediately!

For more tips, advice or troubleshooting please visit our website at www.fuelab.com, e-mail message to info@fuelab.com or call our tech department at 618-344-3300 between 8am and 5pm Central Standard Time.

LIMITED LIFETIME WARRANTY

FUELAB, a division of FCP, Inc., having its principal place of business at **1605 Eastport Plaza Drive, Suite 125, Collinsville, IL 62234, USA** ("Manufacturer") warrants its **FUELAB** products (the "Products") as follows:

1. Limited Lifetime Warranty

Manufacturer warrants that the Products sold hereunder will be free from defects in material and workmanship from the date of purchase for so long as the original purchaser owns the Products. This Limited Lifetime Warranty does not extend to any subsequent owner or transferee of the Products. If the Products do not conform to this Limited Lifetime Warranty during the warranty period (as herein above specified), Buyer shall notify Manufacturer in writing of the claimed defects and demonstrate to Manufacturer's satisfaction that said defects are covered by this Limited Lifetime Warranty. If the defects are properly reported to Manufacturer within the warranty period, and the defects are of such type and nature as to be covered by this Limited Lifetime Warranty, Manufacturer shall, at its option and own expense, furnish replacement Products or replacement parts for the defective Products or refund the purchase price. Removal of Products from vehicle, shipping to Manufacturer and installation of the replacement Products or replacement parts shall be at purchaser's expense. (*Vehicle means any automotive, bike or marine transportation device powered by an internal combustion engine to which the Product is attached. This Product is **NOT** intended or designed for use on aircraft, experimental or otherwise.*)

2. Other Limits

THE FOREGOING IS IN LIEU OF ALL OTHER WARRANTIES, EXPRESS OR IMPLIED, INCLUDING BUT NOT LIMITED TO THE IMPLIED WARRANTIES OF MERCHANTABILITY AND FITNESS FOR A PARTICULAR PURPOSE. This Limited Lifetime Warranty does not cover any damage due to: (a) transportation; (b) storage; (c) improper use; (d) failure to follow instructions for the Products or to perform any preventive maintenance; (e) modification; (f) unauthorized repair; (g) normal wear and tear; or (h) external causes such as accidents, abuse, or other actions beyond Manufacturer's reasonable control. This Limited Lifetime Warranty also does not apply to Products upon which repairs have been effected or attempted by persons other than pursuant to written authorization by Manufacturer. This Limited Lifetime Warranty is not extended if we repair or replace the Products.

3. Exclusive Obligation

THIS LIMITED LIFETIME WARRANTY IS EXCLUSIVE. The sole and exclusive obligation of Manufacturer shall at its option be to repair or replace the defective Products in the manner and for the period provided above or to refund the purchase price. Manufacturer shall not have any other obligation with respect to the Products or any part thereof, whether based on contract, tort, strict liability or otherwise.

4. Other Statements

ORAL OR OTHER WRITTEN STATEMENTS BY MANUFACTURER'S EMPLOYEES, REPRESENTATIVES AND/OR RESELLERS DO NOT CONSTITUTE WARRANTIES, SHALL NOT BE RELIED UPON BY BUYER, AND ARE NOT A PART OF THE CONTRACT FOR SALE OR THIS LIMITED LIFETIME WARRANTY.

5. Entire Obligation

This Limited Lifetime Warranty states the entire obligation of Manufacturer with respect to the Products. If any part of this Limited Lifetime Warranty is determined to be void or illegal, the remainder shall remain in full force and effect.

6. Warranty Service

How Do You Get Service?

If something goes wrong with your Product, contact FUELAB at 618-344-3300, or send an e-mail with proof of purchase to: info@fuelab.com for a Return Authorization Number (RMA). After receiving your RMA send the product postage paid, fully insured, with a brief written description of the problem to:

FUELAB Warranty Department, 1605 Eastport Plaza Drive, Suite 125, Collinsville, IL 62234

We will inspect your Product and contact you within three business days of receipt to give the results of our inspection and an estimate of the labor and/or parts charges required to fix the Product, if applicable. If covered under this Limited Lifetime Warranty, Manufacturer will repair or replace the Product and return it to you at no cost or refund the purchase price. If the Product is NOT covered under this warranty and if you authorize repairs, we will return the repaired Product to you COD, or prepaid via credit card, within three business days. If we find no issues with the returned product and it meets all performance specifications, there will be a \$25 charge to cover technician labor and inspection time. Additional return shipping charges will apply. We will return the repaired Product to you COD, or prepaid via credit card, within three business days.

Limitation of Liability

THE REMEDIES DESCRIBED ABOVE ARE YOUR SOLE AND EXCLUSIVE REMEDIES AND OUR ENTIRE LIABILITY FOR ANY BREACH OF THIS LIMITED LIFETIME WARRANTY, OUR LIABILITY SHALL UNDER NO CIRCUMSTANCES EXCEED THE ACTUAL AMOUNT PAID BY YOU FOR THE DEFECTIVE PRODUCT, NOR SHALL WE UNDER ANY CIRCUMSTANCES BE LIABLE FOR ANY CONSEQUENTIAL, INCIDENTAL, SPECIAL OR PUNITIVE DAMAGES OR LOSSES, WHETHER DIRECT OR INDIRECT.

SOME STATES DO NOT ALLOW THE EXCLUSION OR LIMITATION OF INCIDENTAL OR CONSEQUENTIAL DAMAGES, SO THE ABOVE LIMITATION OR EXCLUSION MAY NOT APPLY TO YOU.



www.fuelab.com

1605 Eastport Plaza Drive, Suite 125, Collinsville, IL 62234
800-541-2345