

Operating and Installation Instructions

CAUTION!

This product is to be installed only by persons knowledgeable in the repair and modification of vehicle fuel systems and general vehicle systems modification. Only a qualified technician or mechanic who is aware of applicable safety procedures and fabrication skills should perform the installation of this product.

GASOLINE AND OTHER FUELS ARE FLAMMABLE AND CAN BE EXPLOSIVE!

Perform the installation in a well ventilated location only to minimize the build up of fuel vapors. **NO** open flames, smoking or other sources of ignition are to be present during installation, to prevent fire or explosion that can cause serious injury or death. Grinding, cutting, and drilling must be performed with care to prevent ignition. Draining and removal of all fuel and ventilation of vapors in vehicle and fuel system is recommended when performing such procedures. Proper eye and personal protection is required at all times during installation.

WARNING!

The Vehicle's fuel system may be under pressure! Do not loosen any fuel connections until relieving all fuel system pressure. Consult an applicable service manual for instructions to relieve fuel system pressure safely.

This product is intended for racing, off-road, or marine use only. This fuel system component may not be legal for sale or use on emission controlled motor vehicles; consult local, state and national laws.

This Fuel Pump is compatible only with Pump or Racing Gasolines, E85 or all Ethanol blends. This Fuel Pump is **NOT** compatible or covered under warranty with use of Diesel or Methanol Fuels

Product Contents:

Check the diagram and list of components (right) to ensure that no components are missing from box. Contact your Fuelab distributor immediately for replacement.

49442 Features and Performance Ratings:

Inlet Port Size	11mm
Outlet Port Size	5/16" Nipple
Rated Flow Rate	90 GPH @ 45 PSI, 13.8V (340 LPH @ 3 Bar)
Maximum Pressure	85 PSI (5.9 Bar)
Operating Voltage	8-18 Volts

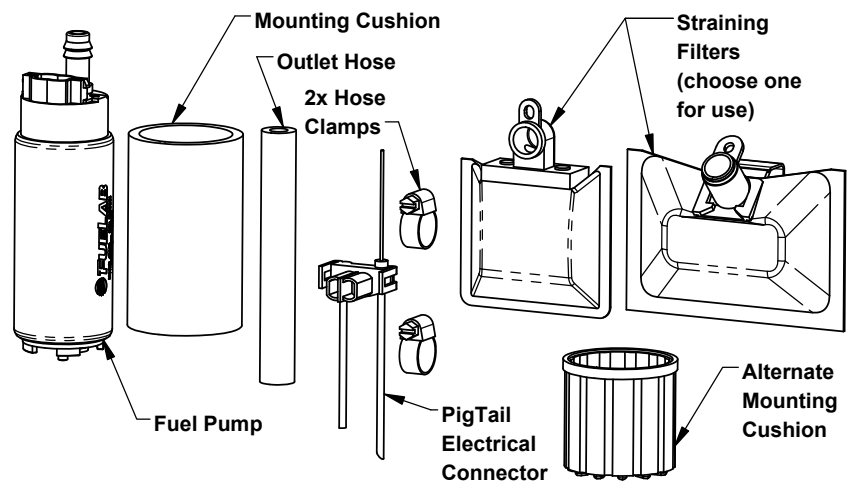

WARNING! This fuel pump has a high capacity flow output, and also consumes a larger than normal electrical current draw. The vehicle's fuel pump wiring may be insufficient to power this fuel pump safely as well as voltage drops through its use will dramatically affect flow output. Use of an aftermarket, high current relay electrical system is highly recommended.

Before Installation, Plan Entire Fuel System:

A complete design plan of entire fuel system must be created for the specific application. These instructions are a guide to help design this plan with respects to integrating this model of fuel pump only. Consult other sources of information and manufacturers instructions for the various components of the fuel system. These instructions are limited to general topics of fuel pump installation and may not include specific information pertaining to your specific application. These instructions are written assuming the use of direct replacement of vehicle's fuel pump. This fuel pump may be integrated in some general carbureted systems using a bypass system. Visit our company website (www.fuelab.com) for specific details pertaining to example fuel systems and other solution ideas. Additional information including advanced troubleshooting, any special alerts and FAQ's pertaining to this and other products is also available. A good design plan for the fuel system must contain consideration for: Pressure and flow rate through various components, quality of components, operating environment (temperature, vibration, shock, general exposure to elements) and local area laws. Begin installation of fuel pump only after a complete plan is established to help avoid fuel system component failure, costly rework, and excessive installation time.

Plumbing Planning Notes:

This fuel pump is for internal use (In-Tank) or mounting only! Although this fuel pump may be used for custom or modified tank or reservoir uses, this fuel pump is sized and configured for OEM replacement of certain vehicles (go to fuelab.com for details). When used with E85 or high percentage Ethanol content fuel, consider replacement of OEM fuel lines with PTFE based fuel line for compatibility. Typical OEM fuel filters may not be compatible with Ethanol. Replacement of OEM filter with Fuelab 818xx Series Fuel Filter using 6 micron micro-fiberglass fuel filter element is recommended (fuel line replacement and/or adapter use may be required). Replacement of fuel filter is highly recommended as a high flow aftermarket filter will take advantage of this Fuelab Pump's performance. A high capacity fuel pressure regulator with larger return line size may also be required for use due to the high capacity of this fuel pump. Monitor fuel pressure to ensure that excessive fuel pressure is not present. Excessive fuel pressure is an indication of an inadequate pressure control/relief system. Please contact Fuelab for any questions regarding compatibility of this product with the vehicle.

Special Note: Use in carbureted systems require a bypass return or relief valve.

Electrical Planning Notes:

Reference below, for schematic wiring diagram example. Use electrical components as described, including electrical connectors that are appropriate for the operating environment of the fuel system, whether its use in street, or racing applications. All electrical connectors for the power leads must be capable of high current draw, note all connections, wire and component rating requirements herein. Solder can be used if crimp connections are not reliable, and use shrink wrap for wire splices for extra reliability. Main wiring schematic diagram, below shows the control of relay by ignition switch. This source can be changed as described, or by a toggle switch or main relay control line powered by original OEM Fuel Pump output circuit. Some forms of racing have specific rules regarding electrical switching of fuel pump, including protective measures such as oil pressure switches that turn off pump in case engine stops running, as a safety feature. Consult appropriate racing guidelines, rules and regulations.

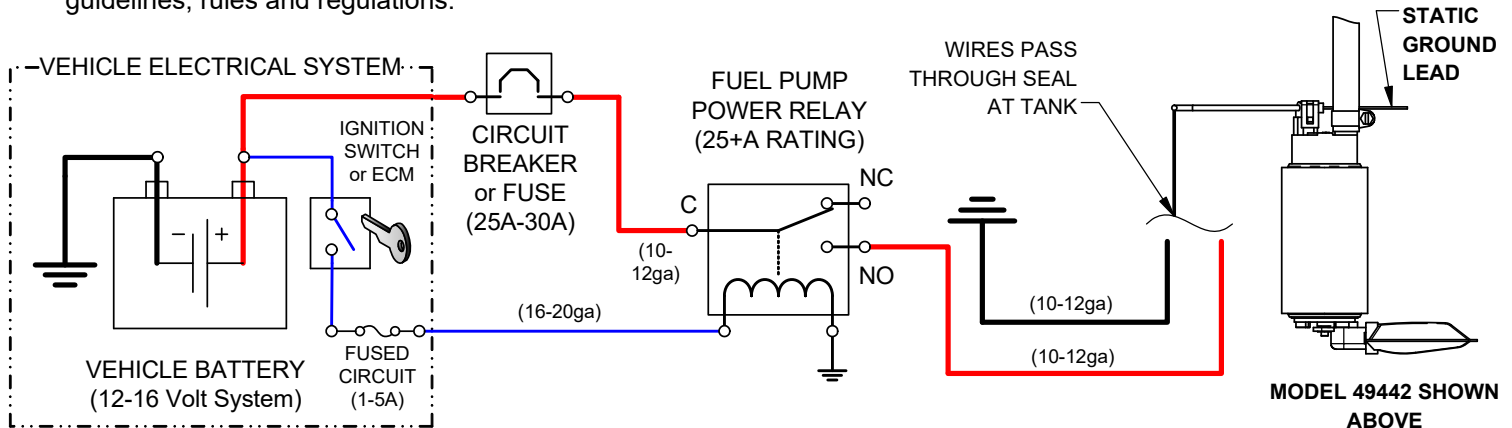

Installation Steps:

1. Disconnect the ground terminal from battery and allow the vehicle's engine and exhaust system to cool. Relieve fuel system pressure per applicable service manual. Follow all Warnings, Cautions and Instructions written on previous pages of these instructions.
2. Drain or remove fuel from the fuel tank. If fuel tank requires removal for fuel tank replacement, be sure to drain or remove as much fuel as possible, to minimize weight and reduce possible spillage. Typical use for the fuel pump include removal of OEM fuel pump through removal a fuel pump hanger or mounting assembly from fuel tank. Remove pump mounting assembly from fuel tank, and inspect for damage, including the main tank seal or module. Typically, replacement parts for the mounting assembly are available through OEM dealers and auto parts stores or distributors. Inspect for cracking or broken components.
3. Remove fuel pump from mounting assembly and compare this Fuelab Pump with the original pump, comparing for similar size, geometry and straining filter size. Place Cushion over outer sleeve of Fuelab Pump and attach Straining Filter to inlet. This system includes two different sized inlet straining filters, choose the closest size that will work or replace with OE style straining filter appropriate for application. Attach Fuelab Fuel Pump in same location and manner as original, while keeping the replacement hose section in place (note: Hose Segment provided may require trimming or alternate hose segment may be required for use).
4. Use provided Pigtail Electrical Connector for powering Fuelab Fuel Pump. Ensure proper polarity, and use crimp style butt connectors to splice wiring. Use of Solder is recommended as well for better connection if crimp is not proper. **WARNING:** This Fuelab Fuel Pump is rated for high flow rates and therefore high current draw. OEM electrical fuel pump circuit may be insufficient to operate the fuel pump safely. It is highly recommended that an aftermarket 25 to 30 Amp relay system wired directly to the vehicle's battery be used.

5. Inspect fuel system for any contact of fuel lines or wires with other components that can cause chafing or rubbing. Secure all components and fuel lines. Ensure that moving components of vehicle are clear.
6. Connect the vehicle's battery. Perform initial priming: The Fuel Pump may require priming during initial operation and for moment after depletion of fuel from fuel tank or cell. This action can be accomplished by removing fuel line from fuel rail (downstream of fuel pump and filters), allowing the fuel line to empty fluid into fuel safe container. Operate fuel pump until fuel exits fuel line. Attach fuel line back to the fuel rail after priming fuel pump. After tightening connection, verify leak-free operation while checking fuel rail pressure. If fuel pressure is not high enough, repeat priming procedure to ensure that fuel pump is receiving fuel from tank. Turn on fuel pump (typically by bypassing fuel pump relay) without engine operating. ECU or engine management computer may be controlling the relay. The ECU may only operate pump for a few seconds each time ignition switch is set to on. The pump will have to operate several seconds (30+) to prime and drive air out of the fuel system. Reattach fuel rail line. Start fuel system and inspect for leaks. Inspect vehicle for any leaks. Turn off fuel system and repair any leaks that may be present before continuing.

Fuel System Maintenance Notes:

Periodic inspection and general maintenance is required for longevity and reliability of the fuel system. This action directly affects the fuel pump's performance and reliability. Included with that are periodic inspection and/or filter element replacement. Straining Filters (upstream of pump) should be checked and cleaned at least every 50,000 miles (more often for off-road operating conditions). Replace or clean downstream filters (after pump) every year or 15,000 miles (more often for off-road operating conditions). Dirty fuel filters can block flow and adversely effect fuel system performance as well as can directly damage the fuel pump.

Special alert for E85 or Methanol Users: **DO NOT** use cellulose (paper) based filter elements! Water can contaminate the fuel and break down the element, creating debris that can damage injectors and fuel pump.

Troubleshooting Notes:

Problem (Symptom)	Possible Causes	Possible Solutions
Not operating.	<ul style="list-style-type: none"> • Faulty fuel pump relay. • Faulty, dirty or corroded electrical connections or improperly sized wire. • Debris from tank or plumbing lodged inside pump. 	Check voltage to Fuel Pump, at power terminals. If voltage is steady and consistent (within 1/2 Volt of battery) then contact Fuelab for assistance or repair. If voltage is inconsistent as described, repair or replace electrical components as required.
Not building up fuel pressure.	<ul style="list-style-type: none"> • Incorrect fuel system initial priming procedure. • Improperly mounted fuel pump or low fuel level. 	Repeat procedure for proper priming, check fuel level as well as fuel pump voltage. If condition continues, remove fuel module and check fuel pump mounting and fuel pump wiring.
Loss of fuel pressure or erratic pressure pulsation after several minutes of operation.	<ul style="list-style-type: none"> • Cavitation (vapor lock) due to overheating or restricted inlet. 	Check temperature of return line right after failure. If return line is hot to touch (cannot leave hand on pump due to it being too hot, or above 120°F), then look for sources of heat such as exhaust or fuel rail mountings that could be conducting too much heat. If return line is not hot to the touch, check for inlet restrictions such as improperly vented tank or inspect module and straining filter. Contact Fuelab, as pump may be damaged due to improper operating condition for repair or consultation.

Please do not return this product to your retailer. If you experience any performance, reliability or problems during installation or use of this product, please contact Fuelab immediately!

For more tips, advice or troubleshooting please visit our website at www.fuelab.com, e-mail message to info@fuelab.com or call our tech department at 800-541-2345 or 618-344-3300 between 8am and 5pm Central Standard Time.

LIMITED LIFETIME WARRANTY

FUELAB, a division of FCP, Inc., having its principal place of business at **1605 Eastport Plaza Drive, Suite 125, Collinsville, IL 62234, USA** ("Manufacturer") warrants its **FUELAB** products (the "Products") as follows:

1. Limited Lifetime Warranty

Manufacturer warrants that the Products sold hereunder will be free from defects in material and workmanship from the date of purchase for so long as the original purchaser owns the Products. This Limited Lifetime Warranty does not extend to any subsequent owner or transferee of the Products. If the Products do not conform to this Limited Lifetime Warranty during the warranty period (as herein above specified), Buyer shall notify Manufacturer in writing of the claimed defects and demonstrate to Manufacturer's satisfaction that said defects are covered by this Limited Lifetime Warranty. If the defects are properly reported to Manufacturer within the warranty period, and the defects are of such type and nature as to be covered by this Limited Lifetime Warranty, Manufacturer shall, at its option and own expense, furnish replacement Products or replacement parts for the defective Products or refund the purchase price. Removal of Products from vehicle, shipping to Manufacturer and installation of the replacement Products or replacement parts shall be at purchaser's expense. (*Vehicle means any automotive, bike or marine transportation device powered by an internal combustion engine to which the Product is attached. This Product is **NOT** intended or designed for use on aircraft, experimental or otherwise.*)

2. Other Limits

THE FOREGOING IS IN LIEU OF ALL OTHER WARRANTIES, EXPRESS OR IMPLIED, INCLUDING BUT NOT LIMITED TO THE IMPLIED WARRANTIES OF MERCHANTABILITY AND FITNESS FOR A PARTICULAR PURPOSE. This Limited Lifetime Warranty does not cover any damage due to: (a) transportation; (b) storage; (c) improper use; (d) failure to follow instructions for the Products or to perform any preventive maintenance; (e) modification; (f) unauthorized repair; (g) normal wear and tear; or (h) external causes such as accidents, abuse, or other actions beyond Manufacturer's reasonable control. This Limited Lifetime Warranty also does not apply to Products upon which repairs have been effected or attempted by persons other than pursuant to written authorization by Manufacturer. This Limited Lifetime Warranty is not extended if we repair or replace the Products.

3. Exclusive Obligation

THIS LIMITED LIFETIME WARRANTY IS EXCLUSIVE. The sole and exclusive obligation of Manufacturer shall at its option be to repair or replace the defective Products in the manner and for the period provided above or to refund the purchase price. Manufacturer shall not have any other obligation with respect to the Products or any part thereof, whether based on contract, tort, strict liability or otherwise.

4. Other Statements

ORAL OR OTHER WRITTEN STATEMENTS BY MANUFACTURER'S EMPLOYEES, REPRESENTATIVES AND/OR RESELLERS DO NOT CONSTITUTE WARRANTIES, SHALL NOT BE RELIED UPON BY BUYER, AND ARE NOT A PART OF THE CONTRACT FOR SALE OR THIS LIMITED LIFETIME WARRANTY.

5. Entire Obligation

This Limited Lifetime Warranty states the entire obligation of Manufacturer with respect to the Products. If any part of this Limited Lifetime Warranty is determined to be void or illegal, the remainder shall remain in full force and effect.

6. Warranty Service

How Do You Get Service?

If something goes wrong with your Product, contact FUELAB at 618-344-3300, or send an e-mail with proof of purchase to: info@fuelab.com for a Return Authorization Number (RMA). After receiving your RMA send the product postage paid, fully insured, with a brief written description of the problem to:

FUELAB Warranty Department, 1605 Eastport Plaza Drive, Suite 125, Collinsville, IL 62234

We will inspect your Product and contact you within three business days of receipt to give the results of our inspection and an estimate of the labor and/or parts charges required to fix the Product, if applicable. If covered under this Limited Lifetime Warranty, Manufacturer will repair or replace the Product and return it to you at no cost or refund the purchase price. If the Product is NOT covered under this warranty and if you authorize repairs, we will return the repaired Product to you COD, or prepaid via credit card, within three business days. If we find no issues with the returned product and it meets all performance specifications, there will be a \$25 charge to cover technician labor and inspection time. Additional return shipping charges will apply. We will return the repaired Product to you COD, or prepaid via credit card, within three business days.

Limitation of Liability

THE REMEDIES DESCRIBED ABOVE ARE YOUR SOLE AND EXCLUSIVE REMEDIES AND OUR ENTIRE LIABILITY FOR ANY BREACH OF THIS LIMITED LIFETIME WARRANTY, OUR LIABILITY SHALL UNDER NO CIRCUMSTANCES EXCEED THE ACTUAL AMOUNT PAID BY YOU FOR THE DEFECTIVE PRODUCT, NOR SHALL WE UNDER ANY CIRCUMSTANCES BE LIABLE FOR ANY CONSEQUENTIAL, INCIDENTAL, SPECIAL OR PUNITIVE DAMAGES OR LOSSES, WHETHER DIRECT OR INDIRECT.

SOME STATES DO NOT ALLOW THE EXCLUSION OR LIMITATION OF INCIDENTAL OR CONSEQUENTIAL DAMAGES, SO THE ABOVE LIMITATION OR EXCLUSION MAY NOT APPLY TO YOU.